

Eltrac 471

Operating Instructions



Copyright:



Enraf-Nonius B.V.
Vareseweg 127
3047 AT Rotterdam
The Netherlands
Tel: +31 (0)10 – 20 30 600
Fax: +31 (0)10 – 20 30 699
info@enraf-nonius.nl
www.enraf-nonius.com

Partnumber: 1671751_40
September 4, 2014

Eltrac

Operating Instructions



Copyright:



Enraf-Nonius B.V.
Vareseweg 127
3047 AT Rotterdam
The Netherlands
Tel: +31 (0)10 – 20 30 600
Fax: +31 (0)10 – 20 30 699
info@enraf-nonus.nl
www.enraf-nonus.com

Part number: 1671751_40
September 4, 2014



TABLE OF CONTENTS

1	FOREWORD	6
1.1	Intended User/Operator	6
1.2	Product Liability	6
2	PRODUCT DESCRIPTION	6
3	PRECAUTIONARY INSTRUCTIONS	7
4	INTENDED USE	8
4.1	Indications	8
4.2	Contra-indications	8
5	PACKAGE CONTENTS	9
6	INSTALLATION	9
6.1	Connection to mains supply	9
6.2	Disconnection from mains supply	9
6.3	Attachment carabiner hook	9
6.4	Mounting on the traction frame	10
7	APPLICATION INFORMATION	10
7.1	Operating sequence example	10
7.2	Cervical traction	10
7.3	Cord guidance	10
8	OPERATING INSTRUCTIONS	11
8.1	Operator controls	11
8.2	Basic Operation	12
8.2.1	Navigation	12
8.2.2	Home	13
8.2.3	Protocols	13
8.2.4	Favorites	13
8.2.5	Manual Operation	14
8.2.6	Treatment screen	14
8.2.7	System settings	16
8.2.8	Shutting device down	16
9	MAINTENANCE AND TROUBLESHOOTING	17
9.1	Cleaning and Disinfection	17
9.1.1	Cleaning of apparatus	17
9.1.2	Cleaning display panel	17
9.2	Warning Messages, Error Messages and Troubleshooting	17
9.2.1	Self-test	17



9.2.2	Patient stop switch	17
9.2.3	Threshold cervical traction	17
9.3	Technical Maintenance.....	17
9.4	End of life.....	18
10	SPECIFICATIONS.....	19
10.1	Technical data	19
10.2	Safety and Performance standards	19
10.3	EMC details.....	19
11	ORDERING INFORMATION	22

1 Foreword

1.1 Intended User/Operator

This manual has been written for the owners and operators of the Eltrac 471. It contains general instructions on operation, precautionary practices, maintenance and parts information. In order to maximize the use, efficiency and lifespan of your unit, please read this manual thoroughly and become familiar with the controls as well as the accessories before operating the unit.

This device is designed to only be used by or under the supervision of persons using the medical device in the course of their work and in the framework of a professional healthcare activity, who understand the benefits and limitations of electrotherapy and ultrasound therapy. I.e. "professional users".

WARNING (USA only):

The Eltrac 471 is a prescription device that should only be used under the supervision or by the order of a physician or other licensed healthcare provider.

Specifications put forth in this manual were in effect at the time of publication. However, owing to Enraf-Nonius her policy of continual improvement, changes to these specifications may be made at any time without obligation on the part of Enraf-Nonius.

1.2 Product Liability

A law on Product Liability has become effective in many countries. This Product Liability law implies, amongst other things, that once a period of 10 years has elapsed after a product has been brought into circulation, the manufacturer can no longer be held responsible for possible shortcomings of the product.

To the maximum extent permitted by applicable law, in no event will Enraf-Nonius or its suppliers or resellers be liable for any indirect, special, incidental or consequential damages arising from the use of or inability to use the product, including, without limitation, damages for loss of goodwill, work and productivity, computer failure or malfunction, or any and all other commercial damages or losses, even if advised of the possibility thereof, and regardless of the legal or equitable theory (contract, tort or otherwise) upon which the claim is based. In any case, Enraf-Nonius's entire liability under any provision of this agreement shall not exceed in the aggregate the sum of the fees paid for this product and fees for support of the product received by Enraf-Nonius under a separate support agreement (if any), with the exception of death or personal injury caused by the negligence of Enraf-Nonius to the extent applicable law prohibits the limitation of damages in such cases. Enraf-Nonius cannot be held liable for any consequence resulting from incorrect information provided by its personnel, or errors incorporated in this manual and / or other accompanying documentation (including commercial documentation).

The opposing party (product's user or its representative) shall disclaim Enraf-Nonius from all claims arising from third parties, whatever nature or whatever relationship to the opposing party.

2 Product Description

The ELTRAC 471 is a computer-controlled device for traction therapy. This device is intended for use by qualified personnel in physiotherapy, rehabilitation and adjacent areas.

By means of a touch-screen interface, the device can be operated in a simple way.

All the popular traction therapies can be selected. Pre-programmed protocols can be used and manually set therapies can be stored. Up to five types of therapy can be sequentially programmed. Also, during the treatment parameters can be adjusted.

The motor in the device delivers via the cord and the to be connected accessories, the necessary traction to the patient (between 15 and 900 Newton). The Enraf-Nonius accessories which are suitable for use with the Eltrac 471, are used for lumbar and cervical traction.

3 Precautionary Instructions



In this section general warnings and precautions are listed, that you should be aware of when using the Eltrac 471.

WARNING:

- Federal law (USA only) restricts this device to sale by, or on the order of, a physician or licensed practitioner. This device should be used only under the continued supervision of a physician or licensed practitioner.
- Make certain that the unit is electrically grounded by connecting only to a grounded electrical service receptacle conforming to the applicable national and local electrical codes.
- You should be aware of the contraindications.
- Do not use force greater than 200N for cervical traction.
- Do not operate the unit in the vicinity (less than 2 meters distance) of a short-wave device.
- The patient must be at all times within sight of the practitioner.
- The device should not be used in so-called wet rooms (hydrotherapy rooms).
- This device is not suitable for use in the presence of flammable anesthetics mixture with air, oxygen, or nitrous oxide.
- This device should be kept out of the reach of children.

CAUTION:

- Read, understand and practice the precautionary and operating instructions. Know the limitations and hazards associated with using any electrical stimulation device. Observe the precautionary and operational stickers placed on the unit.
- Use of controls or adjustments or performance of procedures other than those specified herein may result in hazardous exposure.
- Use the Eltrac 471 only in conjunction with the appropriate accessories from Enraf-Nonius BV.
- This unit should be operated, transported and stored at temperatures between 10 and 40° C (50° and 104° F) with a relative humidity ranging from 10-90%, non-condensing and an atmospheric pressure between 500 and 1060 hPa.
- Do not expose the unit to direct sunlight, heat radiated from a heat radiator, excessive amounts of dust, moisture, vibrations and mechanical shocks.
- In the case of ingress of liquids, unplug the unit from the mains supply and have it checked by an authorized person (see the paragraph on maintenance).
- Before administering any treatment to a patient you should become acquainted with the operating procedures for each mode of treatment available, as well as the indications, contra-indications, warnings and precautions. Consult other resources for additional information regarding the application of electrotherapy.

	<p>Follow the instructions in the user manual</p> <p>It is important that you read, understand and observe the precautionary and operating instructions.</p>
	<p>TYPE B APPLIED PART According IEC60601-1</p>
	<p>Emergency stop</p>





Connection for remote control

4 Intended Use

The ELTRAC 471 is a computer-controlled device for traction therapy. This device is intended for use by qualified personnel in physiotherapy, rehabilitation and adjacent areas.

By means of a touch-screen interface, the device can be operated in a simple way.

All the popular traction therapies can be selected. Pre-programmed protocols can be used and manually set therapies can be stored. Up to five types of therapy can be sequentially programmed. Also, during the treatment parameters can be adjusted.

The motor in the device delivers via the cord and the to be connected accessories, the necessary traction to the patient. The Enraf-Nonius accessories which are suitable for use with the Eltrac 471, are used for the performance of lumbar and cervical traction.

4.1 Indications

- Lumbar disc herniation
- Cervical disc herniation
- Mobility restrictions of lower extremity
- Low Back Pain
- Radiculopathy
- Disfiguring dorsopathies
- Overload-induced cervical pain
- Spondylosis

4.2 Contra-indications

General:

- Ligamentous instability
- Osteomyelitis
- Discitis
- Primary or metastatic bone tumor
- Spinal cord tumor
- Severe osteoporosis
- Untreated hypertension
- Severe anxiety
- Clinical signs of myelopathy
- Inadequate expertise of the practitioner providing the treatment

Cervical:

- Vertebral basilar artery insufficiency
- Rheumatoid arthritis and other connective tissue disorder
- Midline herniated nucleus pulposus
- Acute torticollis

Lumbal:

- Restrictive lung disease or other respiratory disorders

5 Package Contents

Device

1671901 Eltrac 471

Standard accessories Eltrac 471:

1471800 Patient stop switch
1471801 Fixing knobs, set of 4
1471806 Nylon cord 170 cm with carabiner hook
1671751 Operating Instructions Eltrac 471
3444290 Power cord

6 Installation

6.1 Connection to mains supply

Insert the mains cable into socket [5] and connect it to a wall socket.

CAUTION:

- Do not place the device in a location where the power cord could be tripped over or pulled out during treatment.
- Do not attempt to use the device if it is not properly grounded. Make certain that the device is electrically grounded by connecting it only to a grounded electrical service receptacle conformable with the applicable national and local electrical codes regarding medical environments.

Turn on the device with push button [4]

The device will initialize and perform a self-test. This may take a while.

At the end of the self-test the device enters the Home menu and is ready for use.

6.2 Disconnection from mains supply

Turn off the device with push button [4]

6.3 Attachment carabiner hook

CAUTION:

The cord must be attached to the carabiner hook by means of a knot capable of withstanding considerable traction, without coming undone. A suitable knot is shown in the figure below.

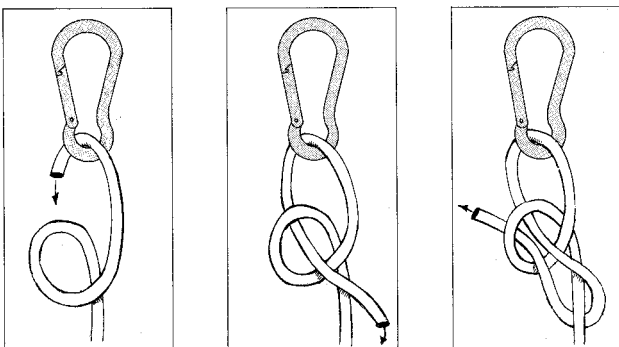

6.4 Mounting on the traction frame

The Eltrac 471 may be mounted on different Enraf-Nonius (traction) benches by way of a traction frame. Moreover, the device may be mounted on the mobile traction frame for cervical traction. For mounting instructions, please refer to the documentation supplied with the traction frames.

7 Application Information

7.1 Operating sequence example

As the operating sequence is dependent on the therapy and accessories employed, only one example is given.

Requirements

Eltrac 471 and traction table
Pelvic belt
Thoracic belt
Flexi stool
Fixation clamps (2x)

- a. Slide the rolling traction section of the table up against the foldable section, and lock it in position.
- b. Lay the pelvic belt against the cranial edge of the rolling traction section.
- c. Lay the thoracic belt against the caudal edge of the foldable section.
- d. Slide the two fixation clamps into the tube underneath the foldable section.
- e. Fit the fixation straps to the fixation clamps.
- f. Adjust the fixation straps: when they are stretched out, the thoracic belt still touches the caudal edge of the foldable section.
- g. Place the patient in position, place the flexi stool and fasten the belts.
- h. Attach the carabiner hook of the cord to the pelvic belt.
- i. Hand over the patient stop switch to the patient and explain its operation.
- j. Release the rolling traction section.
- k. Start the treatment.
- l. If necessary, adjust the parameters during treatment.
- m. After treatment, the patient should have sufficient time to recover.

7.2 Cervical traction

For cervical traction forces over 200 Newton are not suitable. By setting the traction force, a warning will be issued when exceeding this. To ensure safe use, traction force over 200 Newton can only be selected in case it is confirmed not to perform cervical traction.

7.3 Cord guidance

CAUTION:

Make sure the cord is guided over the pulley as shown in the left drawing.

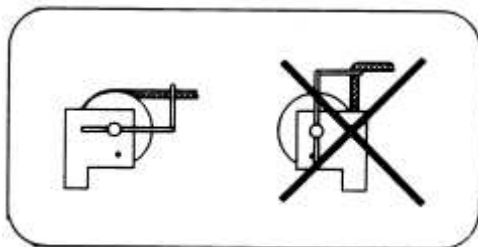

8 Operating Instructions

8.1 Operator controls

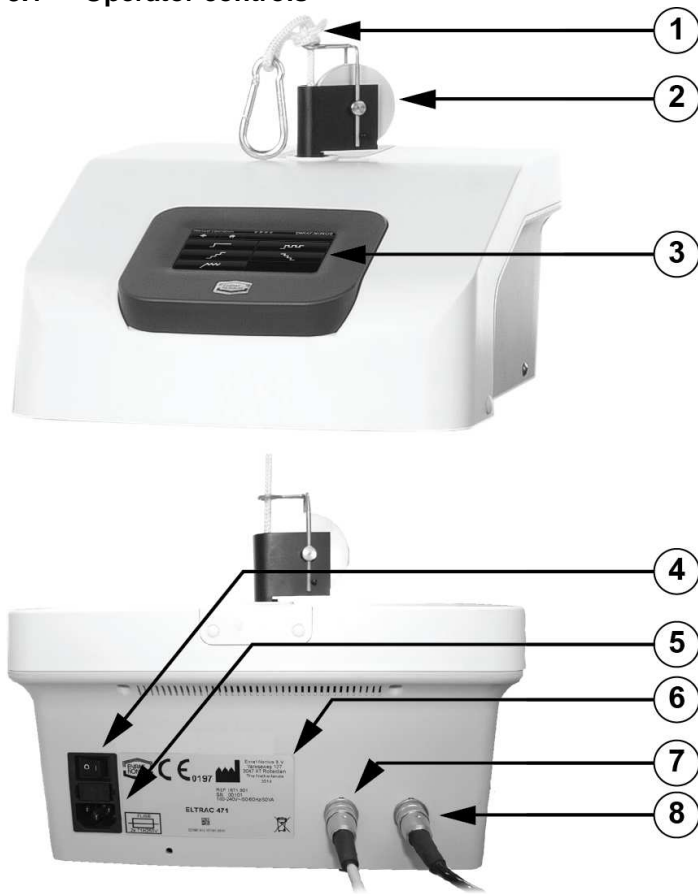

[1] **Cord**

[2] **Pulley**

[3] **Display with touch screen**

[4] **Power switch**

0 Device disconnected from mains supply

1 Device connected to mains supply

[5] **Mains input and mains fuses**

[6] **Type number plate**

Provides information of the device like type and serial number, as well as data on mains voltage and maximum current consumption.

[7] **Connection patient stop switch**















[8] **Connection remote control**

8.2 Basic Operation

Switch on the device as described in paragraph 6

8.2.1 Navigation

The following buttons can be displayed on the navigation bar.

Button	Significance
	Back, return to previous screen.
	Continue, continue to next screen.
	Home, return to Home screen.
	<i>Page number / number of pages in multi-page menu screens or treatment step number / number of treatment steps in sequential protocols.</i>
	Arrow up. Scrolls through pages.
	Arrow down. Scrolls through pages.
	Store therapy parameters or a programmed sequential protocol as favourite.
	Delete.
	Pause / Interrupt treatment. Power will be reduced to zero.
	Start / Continue treatment.
	Accept selected option.
	Stop. Power reduces till zero.
	Emergency stop. Power reduces till zero at maximum speed.
	System settings.
	Remote control is connected.

Please select a menu item by pressing the relevant button to navigate to the next screen. You can return to the previous screen by pressing the back arrow at the top of the screen. You can return to the Home menu anywhere during navigation, by pressing the home button.

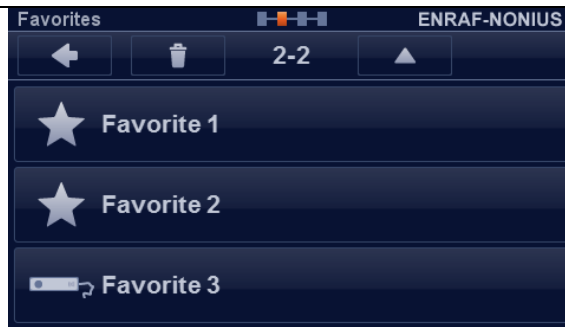
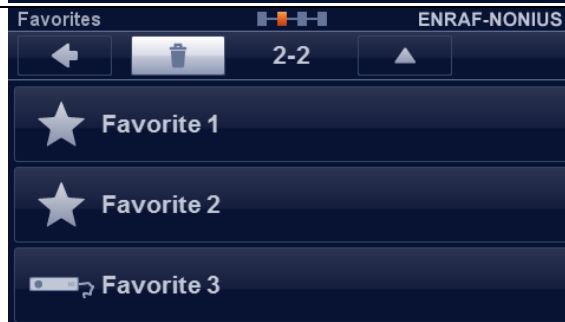
<p>8.2.2 Home</p>	
<p>The Home menu provides access to the following functions:</p> <ul style="list-style-type: none"> • Protocols • Favourites • Manual operation • System settings <p>(The button for system settings is located at the top right-hand side of the navigation bar)</p>	 <p>The screenshot shows the top navigation bar with 'Eltrac 471' on the left and 'ENRAF-NONIUS' on the right. A settings gear icon is in the top right corner. Below the bar are three menu items: 'Clinical Protocols' with a document icon, 'Favorites' with a star icon, and 'Manual Operation' with a hand icon.</p>
<p>8.2.3 Protocols</p>	
<p><i>Selecting protocols</i></p> <p>After selecting the Protocols menu in the main menu, a list will appear with preprogrammed protocols.</p> <p>Scroll through this list using the arrows on the navigation bar.</p> <p>Select the required protocol by pressing the relevant button.</p>	
<p><i>Protocol information</i></p> <p>For more information about a protocol, press the info button on the left hand side of the protocol.</p>	
<p>8.2.4 Favorites</p>	
<p><i>Retrieving favorites</i></p> <p>After selecting the Favorites in the main menu, a list will appear with prestored favorites.</p> <p>By selecting the required favorite, the treatment screen will appear showing the main parameters of the favorite. If required, each parameter can be adjusted here, see 8.2.6.</p> <p>(A programme that requires use of the remote control will be preceded by the remote control symbol.)</p>	 <p>The screenshot shows the 'Favorites' screen with a navigation bar at the top containing a back arrow, a trash bin icon, '2-2', and a forward arrow. Below the bar are three items: 'Favorite 1' with a star icon, 'Favorite 2' with a star icon, and 'Favorite 3' with a star icon and a remote control symbol.</p>
<p><i>Removing favorite</i></p> <p>To remove a favorite, first press the recycle bin and then the favorite you want to remove.</p>	 <p>This screenshot is identical to the previous one, but the trash bin icon in the navigation bar is highlighted with a white background, indicating it is the active element.</p>

8.2.5 Manual Operation

Form of therapy

After selecting Manual Operation in the main menu, the possible forms of therapy appear.

Depending on the selected form of therapy, you will be prompted to enter the required parameters.



Setting of parameters

Use the arrow keys on the screen to adjust the parameter.

Use the tick on the navigation bar to confirm the set value.

The screen for setting the next parameter appears. You can use the back key on the navigation bar to return to the previous parameter.



Setting with body weight

You have the option to set the body weight and a percentage to determine the required power. To do this, press the "Setting with body weight" key at the bottom of the screen.

Set the patient's body weight. In the next screen you can insert the percentage of the body weight.

(The desired tractive power will be calculated for you. The absolute value will be shown when you are in the treatment screen)



Speed

The speed with which the tractive power changes can be set very accurately using the arrow keys. Moreover you can use the three pictograms at the bottom of the screen: slow, medium and fast.



When all required parameters have been set, you will arrive at the treatment screen.

8.2.6 Treatment screen





Screen lay-out

At the right-hand side of the treatment screen you will be able to quickly view the main parameter settings.

In the middle of the screen the treatment setting will be depicted in a diagram.

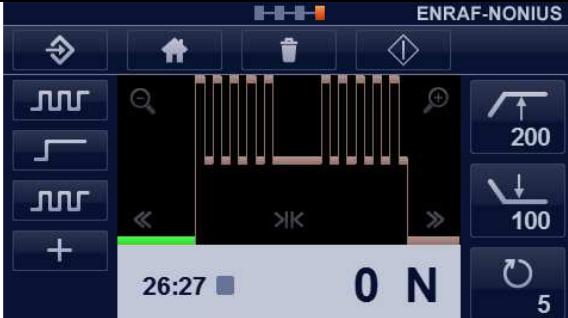
On the left-hand side of the screen you see a symbol for the therapy form setting. In the case of a sequential programme you will find the sequence of the programmed forms of therapy from top to bottom.



<p><i>Adjusting parameters</i></p> <p>You can adjust the parameters by pressing the relevant button on the right-hand side of the screen and using the arrow keys in the next screen. Confirm using the tick on the navigation bar.</p> <p>In order to browse through all parameters for a therapy form, select the relevant symbol on the left-hand side.</p> <p><i>NB:</i> Not all of the parameters can be adjusted during treatment.</p>	
<p><i>Diagram</i></p> <p>The keys in the centre of the treatment screen offer the option to zoom in and out of the depiction or to move across the time line.</p> <p>The keys appear when the screen is touched once in the centre.</p> <p>(After a number of seconds the depiction will automatically return to the current position in the treatment)</p>	
<p><i>Sequential programming</i></p> <p>By pressing the + key you can add another form of therapy. The device will ask you to enter the parameters for this other form of therapy.</p> <p>To remove part of a sequential programme, you start by selecting the recycle bin on the navigation bar immediately followed by pressing the symbol of the relevant form of therapy in the left-hand column.</p>	
<p><i>Start / Pause / Stop</i></p> <p>You start the therapy with the start button on the navigation bar.</p> <p>To interrupt the treatment, press on the pause button on the navigation bar. This button will appear in the place of the start button when the treatment is in progress.</p> <p>To continue the treatment, press the start button.</p> <p>To stop the treatment, press the STOP button on the navigation bar. This will appear when the treatment is in progress.</p>	
<p><i>Storing favorites</i></p> <p>When a treatment screen has been set completely as required, the setting can be stored as a favorite. As long as the treatment has not been started, a Store button is available on the navigation bar. Press on the Store button to store your settings.</p> <p>Also after termination, stopping or pausing of the treatment, the treatment remains visible on the screen, and can still be stored as a favorite.</p>	

Naming your favorite

Using the keyboard, type in the name of your favorite setting.
Press ✓ to store your favorite setting under the name entered by you.

Once stored, favourites may be retrieved from the Favourites menu.

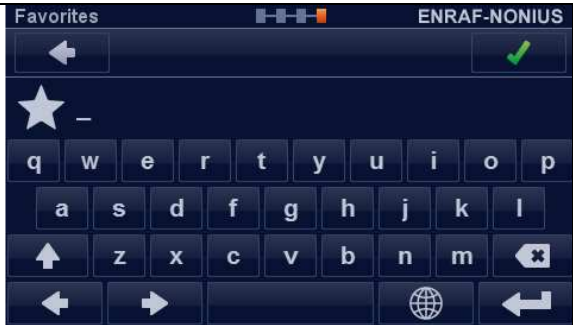

Programming

A treatment can be programmed in two ways.

1. Start with manual operation and run through the menu until the treatment screen is shown. For a sequential programme, add multiple forms of therapy.
2. Go to favorites and select a previously stored treatment as a basis for a new programme. On the treatment screen, any parameters can be adjusted before storing or starting the treatment.



8.2.7 System settings

Select the pictogram for system settings on the navigation bar of the Home menu.



On this screen you can set the device on the basis of your personal preferences. You can change or adjust various settings. Example:

Language: Press the language button and select in the following screen the required language using the arrow keys. Press the tick on the navigation bar to confirm.

Clarity: This enables you to change the intensity of the back light.

Press the home button on the navigation bar to return to the Home menu.



8.2.8 Shutting device down

Turn off the device with the power switch.



9 Maintenance and Troubleshooting

9.1 Cleaning and Disinfection

9.1.1 Cleaning of apparatus

To clean the unit, turn it off and unplug the power supply. Clean the unit with a damp cloth. Do not use abrasive cleaners. A small amount of mild household detergent may be used, if needed.

9.1.2 Cleaning display panel

The display panel has an anti-reflection coating and should be cleaned carefully. Use a soft and dry cotton cloth or micro fiber tissue to clean the panel. To remove fingerprints or grease, use a non-abrasive glass cleaning agent. Apply a small amount of the cleaning agent to a soft cotton cloth and then carefully clean the panel.

CAUTION:

- Do not spray the cleaning agent directly on the glass panel.
- Do not use cleaning agents that contain strong alkalis, lye, acid, detergents with fluoride or detergents with ammonia.

9.2 Warning Messages, Error Messages and Troubleshooting

9.2.1 Self-test

When the apparatus is turned on, it will first execute a self-test. When an error is detected (this being during the self-test as well as during normal operation), a pop-up screen will appear on the display. When the error is displayed, all outputs will be disabled. When this situation occurs, remove all cables and switch the apparatus off and switch it on again. When the error re-appears, stop using the device and contact your supplier

9.2.2 Patient stop switch

The patient stop switch must be connected to socket [7]. Treatment cannot start unless the patient stop switch is connected.

The switch should be handed to the patient and its use should be explained.

Make sure the stop switch can be used by the patient during the whole treatment. If it is pressed during treatment, the traction force will be reduced to the minimum of 15 N at the maximum change over speed. At the same time a buzzer will sound.

9.2.3 Threshold cervical traction

For cervical traction forces greater than 200 Newton are not suitable. When setting the traction force a warning will be issued when exceeding this limit. To ensure safe use, a force higher than 200 Newton can be selected only in case it is confirmed this force will not be applied with cervical traction.

9.3 Technical Maintenance

Electrical safety of the device relies on a properly earthed electrical connection via the power cord. It is therefore necessary to have this connection checked annually.

To ensure continued compliance standard, this unit should be adjusted and safety tested once each year. Procedures laid down in the service manual should be followed. This may be carried out by your supplier, or by another agency, authorized by the manufacturer. It is also recommended that a service history record is maintained. In some countries this is even obligatory.

On request a service manual can be made available containing: spare part list, descriptions, calibration instructions and other information which will assist the user's qualified technical personnel to repair those parts of the equipment which are designated by the manufacturer as repairable.



CAUTION:

- Electrical safety of the device relies on a properly earthed electrical connection via the power cord. It is therefore necessary to have this connection checked annually.
- Use of controls or adjustments or performance of procedures other than those specified herein may result in hazardous exposure to ultrasonic energy.



WARNING:

- This unit operates with high voltages. No attempt should be made to disassemble the unit. Maintenance and repair should be carried out by authorized personnel only. Enraf-Nonius will not be held responsible for the results of maintenance or repairs by unauthorized persons.

9.4 End of life

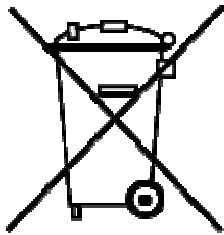

The Eltrac contains materials that can be recycled and/or are noxious to the environment. Specialized companies can dismantle the unit and sort out these materials. When you dispose of the unit, find out about local regulations concerning waste management.

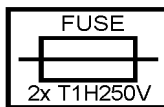

10 Specifications

10.1 Technical data

Mains voltage: 100 – 240 V
Mains frequency: 50-60 Hz
Maximum power: 50 VA
Main fuses: 2 x T1H250V

Dimensions: 30 x 34 x 22 cm (b x d x h)
Weight: 10 kg

Environmental conditions for transport and storage

Temperature: -10° to +70° C
Relative humidity: 10 to 90 % (non condensing)
Atmospheric pressure: 500 to 1060 hPa

Environmental conditions for normal use:

Temperature: 10 to 40 °C
Relative humidity: 10 to 90 % (non condensing)
Atmospheric pressure: 500 to 1060 hPa

Technical modifications reserved

10.2 Safety and Performance standards



Medical device classification IIa

This equipment complies with all essential requirements of the Medical Device Directive (93/42/EEC).



Safety class I (IEC 60601-1)

The unit is equipped with a safety earth and must be connected to a mains plug with earth contact.



Type B

The leakage current and safety earth correspond to standard IEC 60601 -1.

10.3 EMC details

Medical electrical devices such as the Eltrac 471 are subject to special precautions with regard to electromagnetic compatibility (EMC) and must be installed and commissioned in accordance with the EMC advice given in the instructions for use and accompanying documents.

Portable and mobile RF communication systems (e.g. mobile phones) may interfere with medical electrical devices.

The Eltrac 471 should only be operated with the original mains cable specified in the list of contents delivered.

Operating the device with any other mains cable can lead to increased emissions or reduced interference immunity of the device.



Guidance and manufacturer's declaration – electromagnetic interference		
The Eltrac471 is intended for use in the electromagnetic environment specified below. The customer or the user of the Eltrac471 should assure that it is used in such an environment.		
Emissions test	Compliance	Electromagnetic environment – guidance
RF emissions CISPR 11	Group 1	The Eltrac471 uses RF energy only for its internal function. Therefore, its RF emissions are very low and are not likely to cause any interference in nearby electronic equipment. The Eltrac471 is suitable for use in all establishments, including domestic establishments and those directly connected to the public low voltage power supply network that supplies buildings used for domestic purposes.
RF emissions CISPR 11	Class B	
Harmonic emissions IEC 61000-3-2	Class A	
Voltage fluctuations / flicker emissions IEC 61000-3-3	Complies	

The device should not be used when placed immediately next to or stacked on top of other devices. If operation is necessary when immediately next to or stacked on top of other devices, the device should be monitored to ensure it is operating as intended in this arrangement.

Guidance and manufacturer's declaration – electromagnetic immunity			
The Eltrac471 is intended for use in the electromagnetic environment specified below. The customer or the user of the Eltrac471 should assure that it is used in such an environment.			
IMMUNITY test	IEC 60601 test level	Compliance level	Electromagnetic environment – guidance
Electrostatic discharge (ESD) IEC 61000-4-2	± 6 kV contact ± 8 kV air	± 6 kV contact ± 8 kV air	Floors should be wood, concrete or ceramic tile. If floors are covered with synthetic material, the relative humidity should be at least 30 %.
Electrical fast transient/burst IEC 61000-4-4	± 2 kV for power supply lines ± 1 kV for input/output lines	± 2 kV for power supply lines ± 1 kV for input/output lines	Mains power quality should be that of a typical commercial or hospital environment.
Surge IEC 61000-4-5	± 1 kV line(s) to line(s) ± 2 kV line(s) to earth	± 1 kV line(s) to line(s) ± 2 kV line(s) to earth	Mains power quality should be that of a typical commercial or hospital environment.
Voltage dips, short interruptions and voltage variations on power supply input lines IEC 61000-4-11	<5 % <i>UT</i> (>95 % dip in <i>UT</i>) for 0,5 cycle 40 % <i>UT</i> (60 % dip in <i>UT</i>) for 5 cycles 70 % <i>UT</i> (30 % dip in <i>UT</i>) for 25 cycles	<5 % <i>UT</i> (>95 % dip in <i>UT</i>) for 0,5 cycle 40 % <i>UT</i> (60 % dip in <i>UT</i>) for 5 cycles 70 % <i>UT</i> (30 % dip in <i>UT</i>) for 25 cycles	Mains power quality should be that of a typical commercial or hospital environment. If the user of the Eltrac471 requires continued operation during power mains interruptions, it is recommended that the Eltrac471 be powered from an uninterruptible power supply or a battery.
Power frequency (50/60 Hz) magnetic field IEC 61000-4-8	3 A/m	3 A/m	Power frequency magnetic fields should be at levels characteristic of a typical location in a typical commercial or hospital environment.
NOTE <i>UT</i> is the AC mains voltage prior to application of the test level.			

Guidance and manufacturer's declaration – Electromagnetic immunity			
The Eltrac 471 is intended for use in the electromagnetic environment specified below. The customer or the user of the Eltrac 471 should assure that it is used in such an environment.			
Immunity test	IEC 60601 test level	Compliance level	Electromagnetic environment - Guidance
Conducted RF IEC 61000-4-6	3 Vrms 150 kHz to 80 MHz	3 Vrms	Portable and mobile RF communications equipment should be used no closer to any part of the Eltrac471, including cables, than the recommended separation distance calculated from the equation applicable to the frequency of the transmitter. Recommended separation distance $d = 1,17\sqrt{P}$
Radiated RF IEC 61000-4-3	3 V/ m 80 MHz to 2,5 GHz	3 V/m	



$$d = 1,17\sqrt{P} \text{ (80 MHz to 800 MHz)}$$

$$d = 2,33\sqrt{P} \text{ (800 MHz to 2,5 GHz)}$$

Where P is the maximum output power rating of the transmitter in watts (W) according to the transmitter manufacturer and d is the recommended separation distance in meters (m).

Field strengths from fixed RF transmitters, as determined by an electromagnetic site survey ^(a) should be less than the compliance level in each frequency range ^(b) Interference may occur in the vicinity of equipment

marked with the following symbol:



NOTE 1 At 80 MHz and 800 MHz, the higher frequency range applies.

NOTE 2 These guidelines may not apply in all situations. Electromagnetic propagation is affected by absorption and reflection from structures, objects and people.

a Field strengths from fixed transmitters, such as base stations for radio (cellular/cordless) telephones and land mobile radios, amateur radio, AM and FM radio broadcast and TV broadcast cannot be predicted theoretically with accuracy. To assess the electromagnetic environment due to fixed RF transmitters, an electromagnetic site survey should be considered. If the measured field strength in the location in which the Eltrac471 is used exceeds the applicable RF compliance level above, the Eltrac471 should be observed to verify normal operation. If abnormal performance is observed, additional measures may be necessary, such as re-orienting or relocating the Eltrac471.

b Over the frequency range 150 kHz to 80 MHz, field strengths should be less than 3 V/m.

RECOMMENDED SEPARATION DISTANCES BETWEEN PORTABLE AND MOBILE RF COMMUNICATIONS EQUIPMENT AND THE ELTRAC471

The Eltrac471 is intended for use in an electromagnetic environment in which radiated RF disturbances are controlled. The customer or the user of the Eltrac471 can help prevent electromagnetic interference by maintaining a minimum distance between portable and mobile RF communications equipment (transmitters) and the Eltrac471 as recommended below, according to the maximum output power of the communications equipment.

Rated maximum output power of transmitter W	Separation distance according to frequency of transmitter [m]		
	150 kHz to 80 MHz $d = 1,17\sqrt{P}$	80 MHz tot800 MHz $d = 1,17\sqrt{P}$	800 MHz to 2,5 GHz $d = 2,33\sqrt{P}$
0,01	0.12	0.12	0.23
0,1	0.37	0.37	0.74
1	1.17	1.17	2.33
10	3.70	3.70	7.37
100	11.70	11.70	23.33

For transmitters rated at a maximum output power not listed above, the recommended separation distance d in metres (m) can be estimated using the equation applicable to the frequency of the transmitter, where P is the maximum output power rating of the transmitter in watts (W) according to the transmitter manufacturer.

NOTE 1 At 80 MHz and 800 MHz, the separation distance for the higher frequency range applies.

NOTE 2 These guidelines may not apply in all situations. Electromagnetic propagation is affected by absorption and reflection from structures, objects and people.

11 Ordering information

Device

1671901 Eltrac 471

Standard accessories:

1471800 Patient stop switch
1471801 Fixing knob, set of 4
1471806 Nylon cord 170 cm with carabiner hook
1671751 Operating Instructions Eltrac 471
3444290 Power cord

Optional accessories:

5100614 Manumed Traction 4-section (type 926)
5100613 Manumed Traction 4-section (type 916)
3450500 Manumed Traction 2-section (type 004)
3013014 Flexi stool grey, with separate height adjustment for each leg
3447624 Padded neck harness, complete with spreader bar
1471802 Pulley for mobile traction frame (2 required)
3445022 Pelvic belt for Manumed Traction
3445021 Thoracic belt for Manumed Traction
3445512 Mobile traction frame for cervical traction
1471805 Wall bar bracket, for mounting of Eltrac 471 to wall bars
3445038 Traction frame for Manumed Traction H/L (width 430 mm)
3445020 Traction frame Manumed fixed height (width 480 mm)

www.enraf-nonius.com